

REV.	ECN.NO.	MODIFY.CONTENT	DATE
A		NEW	2014/02/29

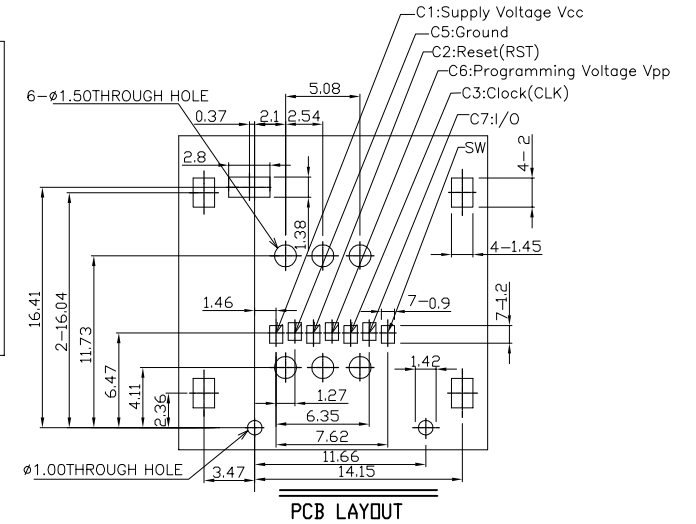
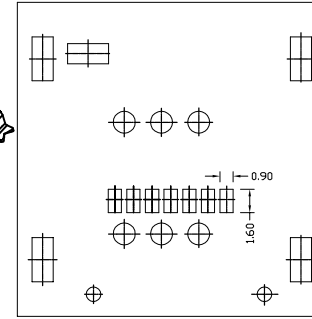
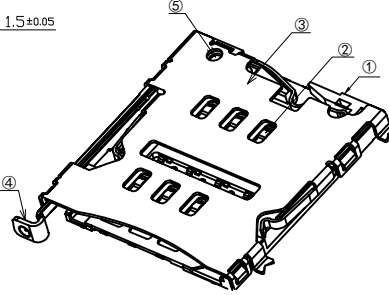
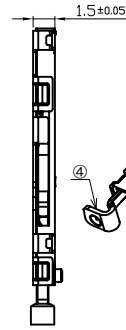
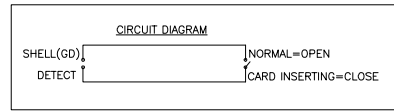
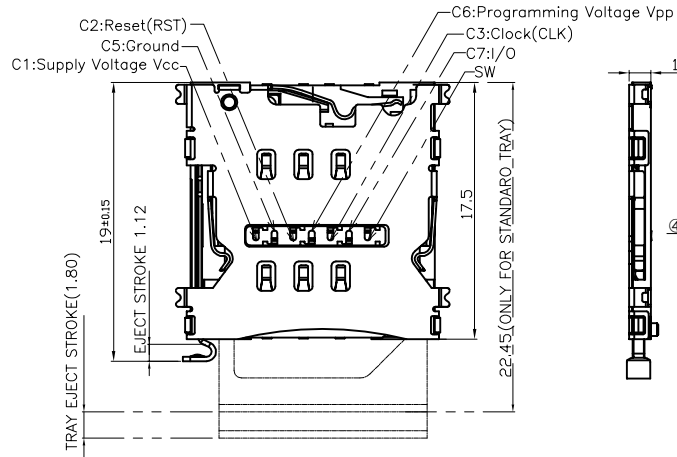

### 钢网建议

#### NOTE:

- ELECTICAL CHARACTERISTICS:
  - VOLTAGE: 30V DC MAX
  - LOW LEVEL CONTACT RESISTANCE: 30 mohms MAX INITIALLY
  - DIELECTRIC WITHSTANDING VOLTAGE: 500V AC MIN FOR 1 MINUTE
  - INSULATION RESISTANCE: 100Mohm MIN (DC 500V FOR 1 MINUTE)
- MECHANICAL CHARACTERISTICS:
  - DURABILITY: 1500 CYCLES
  - OPERATING FORCE (INSERTING & WITHDRAWAL): 1N-10N
- ENVIRONMENTAL CHARACTERISTICS:
  - RANGE: -25°C TO 85°C (INCLUDING TERMINAL TEMP. RISE)
  - STORAGE TEMP: -40°C TO 85°C
- QUANTITY OF PRODUCTS: 1000PCS/REEL MIN
- PLEASE CONTACT SALES REPRESENTATIVE TO VERIFY PRODUCT DETAILS

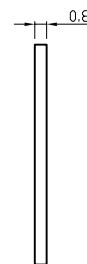
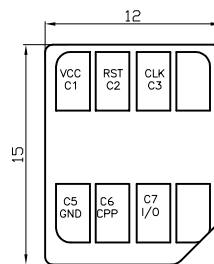
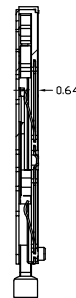
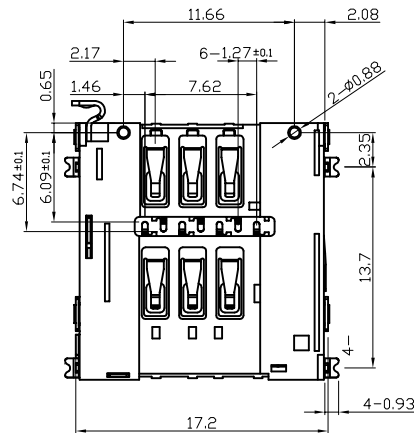
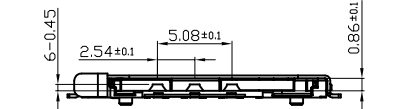

剖面 A-A

GENERAL TOLERANCE		DWG NO.	JYSA0528-013	APPD:	WIND	Scale	1:1
X.±0.45	x'±5'	Title	MICRO SIM CARD 1.5H	CHKD:		UNIT	mm
.X±0.35	.x'±2'			DR:			
.XX±0.25	.xx'±1'	Part NO.	JYS-SIM150-053	Date	2014/02/29		
.XXX±0.15	.xxx'±0.5'						
SHEET	1/1			<b>JYSCONN</b> Shenzhen <b>JYSCONN Electronics Co., LTD.</b>			